

# Platimax



- 峰值高达1800W
- 高达90-94%的效率表现
- 全模块设计



EPM1700EGT拥有常时1700W的大瓦数输出能力，峰值输出高达1800W。采用全插拔线材且整体设计仅180mm，具备高功率密度。6组+12V输出设计搭配各组高容载规格，兼顾安全性与对于高端显卡的兼容性(支援 SLI和CrossFire)。EPM1700EGT设计于高电压地区使用(220-240Vac)，转换效率达90-94%表现(于系统20%-100%负载)，适合专业电竞玩家、高阶图像工作站与各种重度玩家使用。



EPM1700EGT

### 产品特点

- 90 PLUS白金效率  
极高90-94%效率表现(于20-100%负载范围)，可达80 PLUS白金牌等级。

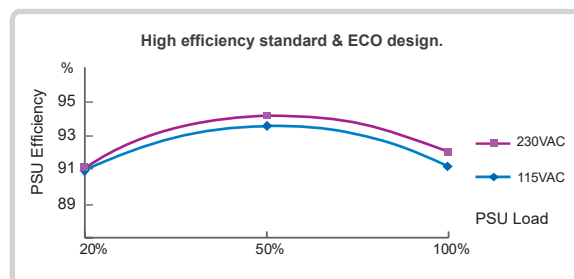

PSU +5Vsb efficiency @ 0.045A load, 230VAC



ENERMAX 2013 ErP Lot 6 Compliant PSU

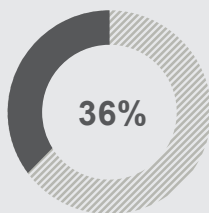

Non 2013 ErP Lot 6 Compliant PSU

- 2013 ErP Lot 6 ready!

高效能+5Vsb电流设计，协助系统符合2013 ErP Lot 6 节能规范。(需搭配符合2013 ErP Lot 6系统)

- 全磁域象限设计

运用变压器四象限磁力技术，提供无可比拟的转换效率，并在千瓦级输出表现上，有卓越的稳定性。

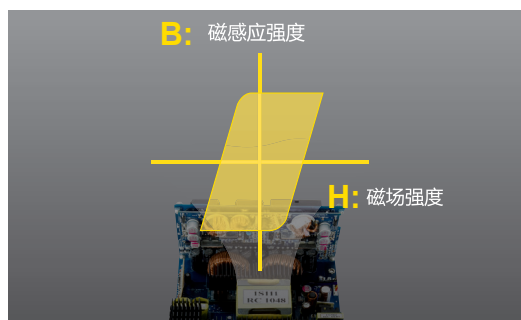

## 铜桥数组转换技术

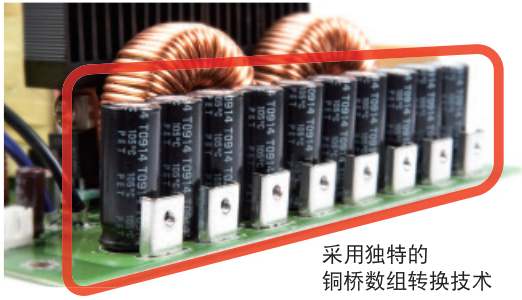

采用独特的  
铜桥数组转换技术

- 比一般传导路径宽4倍，进而降低风阻、压降及电力耗损
- 电压稳定性提升60%，进而提供更稳定、更干净的电力输出

### 输出电压稳定性

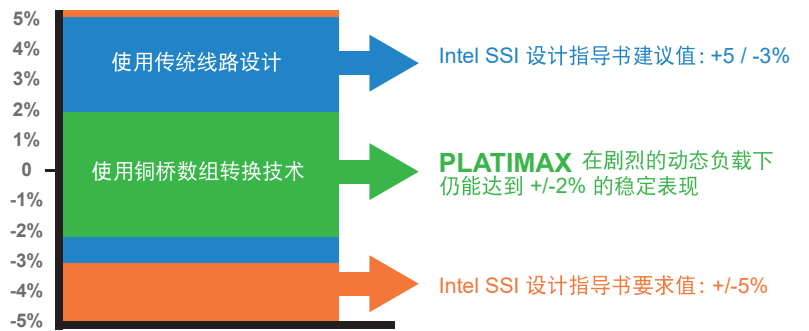

## 高精密度变压器

变压器的创新设计不但提高使用效能，也缩小了变压器的体积，能减少风阻，提升空气对流。

1. 极致的电力密度表现
2. 较传统变压器的体积缩小50%
3. 优异的散热表现
4. 低风阻与风切声

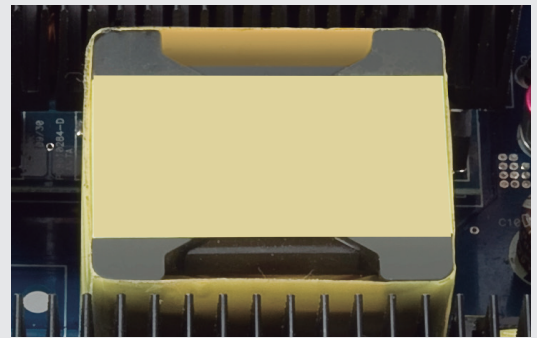

## Zero load ready!

透过DC-DC(直流转直流)的设计确保电压输出稳定及提升效率表现。

## 全日系105°C电解电容

高质量用料，确保稳定性与耐用度。





### 100% 6+2P (8P) PCI-E connector

全面採用 6+2P (8P) PCI-E 连接头，支持新世代高阶显示适配器用电需求。

### 全模块设计

全模块化的线材设计，让使用者能依不同的系统需求，弹性地选用所需线材。

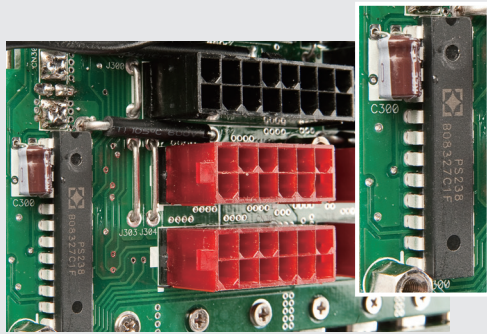
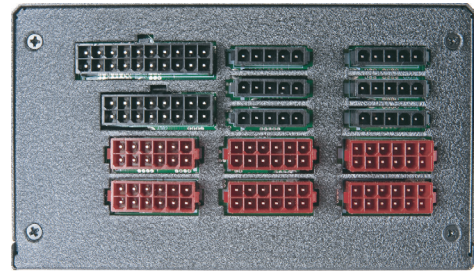

### 安全警卫

先进多重安全设计，包含：过电流(OCP)、过电压(OVP)、低电压(UVP)、过负载(OPP)、过温度(OTP)、短路(SCP)与防突波&涌浪(SIP)等，提供系统全方位的保护。

### 强化型一体式散热片

不寻常的一体式散热片设计，有效降低风阻，增加机体内部风流量，提升散热表现。

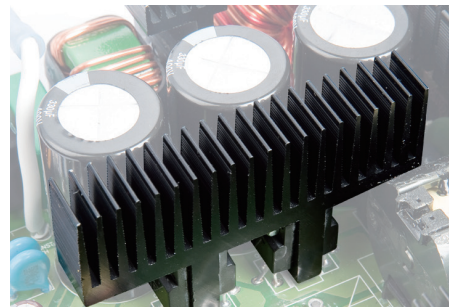





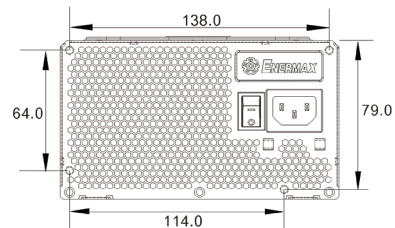
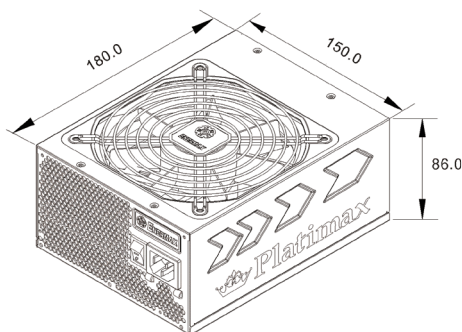

## 尺寸

单位:mm



## 线材与接头

线材\型号	EPM1700EGT	
2 x PCI-E 6+2 Pin		5 x 500mm
8P & 4P 12V CPU/RAM		1 x 600mm
4 x SATA		3 x 450/600/750/900mm
4 x 4P Molex + FDD		2 x 450/600/750/900/1050mm
2 x SATA + 2 x 4P Molex		1 x 450/600/750/900mm
24P & 8P MB/CPU		1 x 600/650mm

## 产品规格

型号	EPM1700EGT	
交流输入电压	220-240VAC, Active PFC	
	50-60Hz	
交流输入电流	9.0-8.0A	
直流输出		
	Rated	Combined
3.3V	25A	140W
5V	25A	
12V1	20A	
12V2	20A	1692W (141A)
12V3	30A	
12V4	30A	
12V5	30A	
12V6	30A	
-12V	0.5A	6W
+5Vsb	4A	20W
总瓦数	1700W	
尺寸	150(W) x 86(H) x 180(D)mm	
      		
包装信息		
条形码	EAN	4713157721150
彩盒尺寸	357 x 281 x 108mm	
毛重(彩盒)	4.95kgs	
外箱尺寸	387 x 353 x 308mm	
装箱数量	3pcs	
毛重(外箱)	14.85kgs	